

Green Small Cell Flexible Networks



Mérouane Debbah

<http://www.flexible-radio.com>

Alcatel-Lucent / Supélec

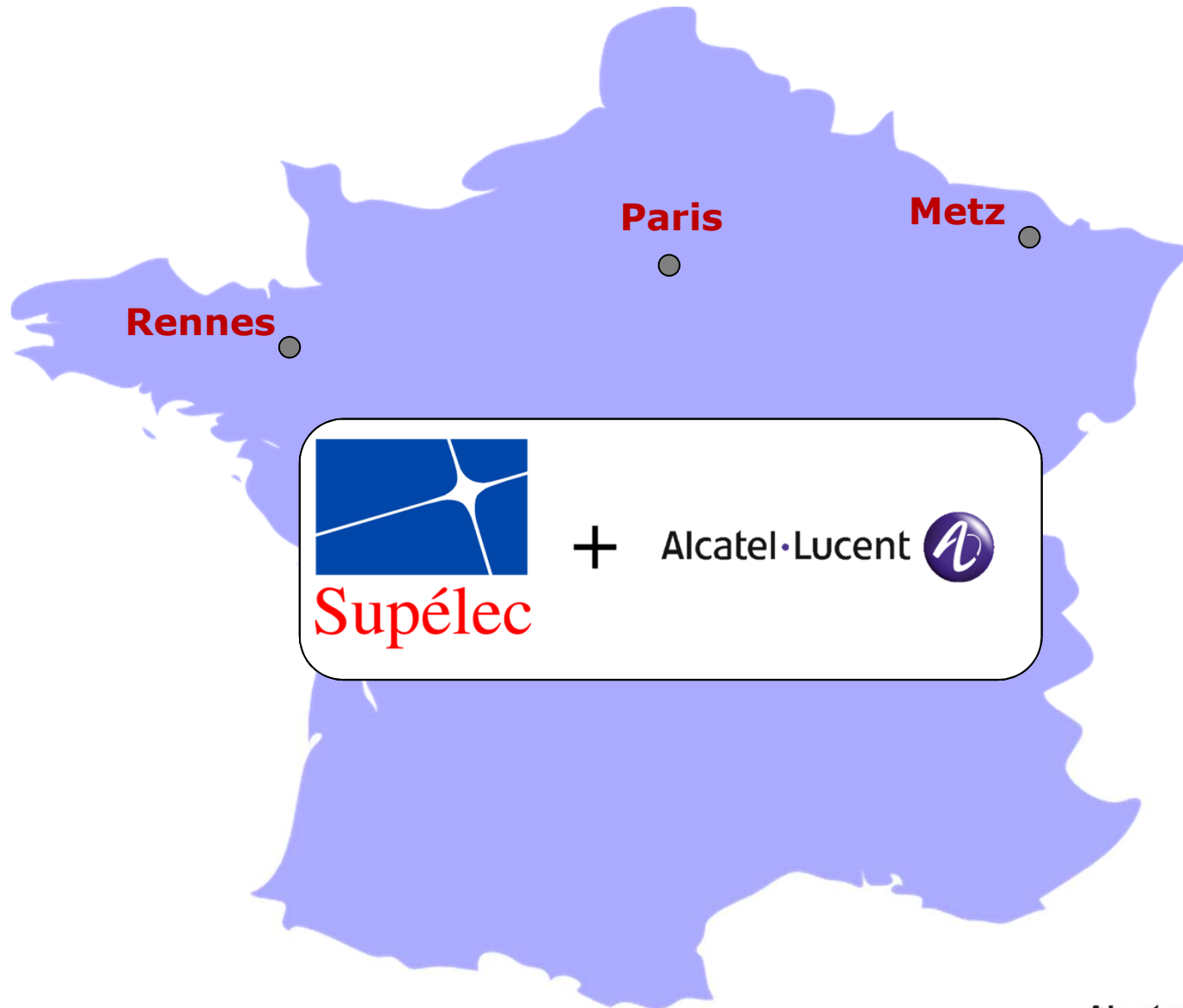

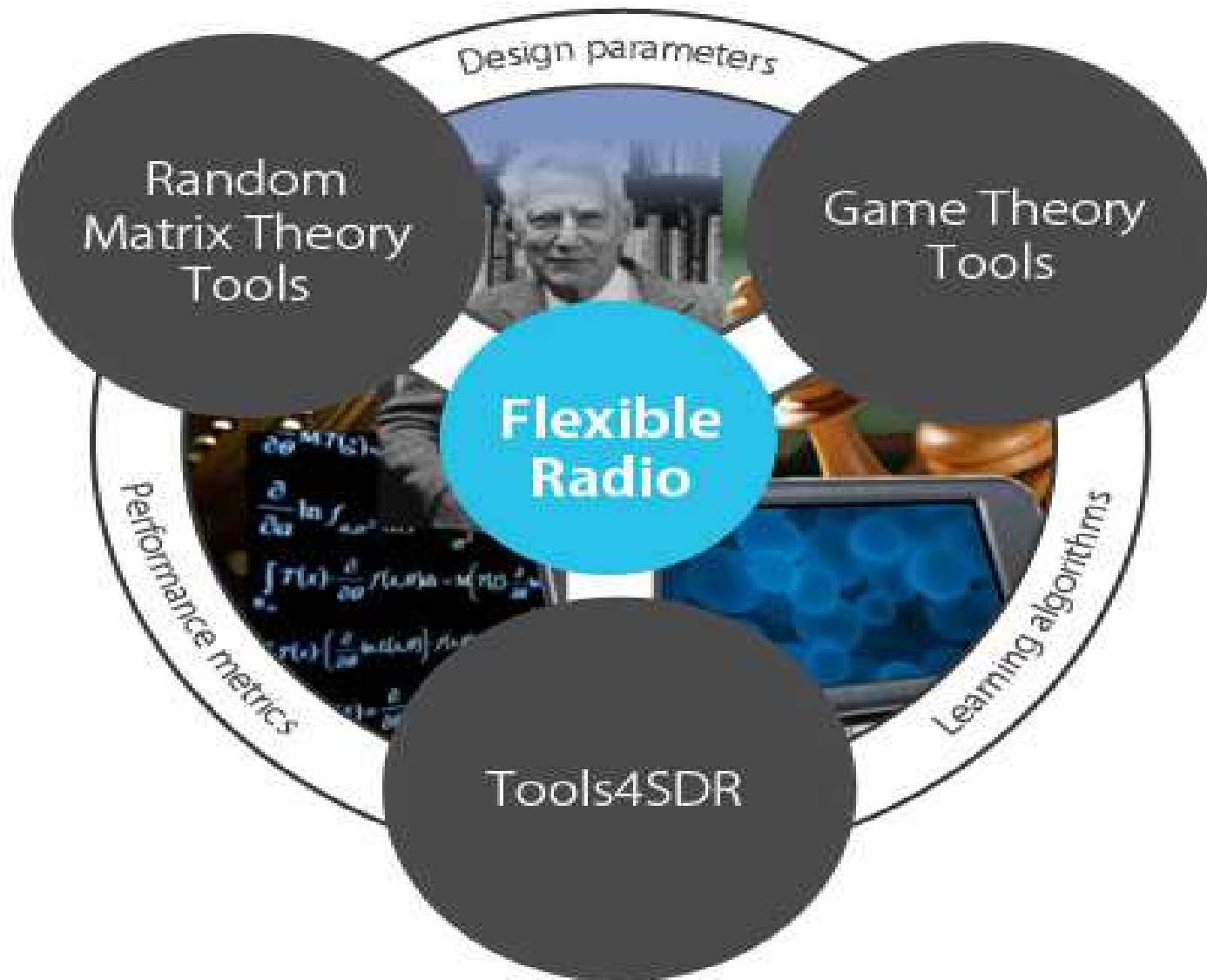

1948: Cybernetics and Theory of Communications

- "A Mathematical Theory of Communication", Bell System Technical Journal, 1948, C. E. Shannon
- "Cybernetics, or Control and Communication in the Animal and the Machine", Herman et Cie/The Technology Press, 1948, N. Wiener

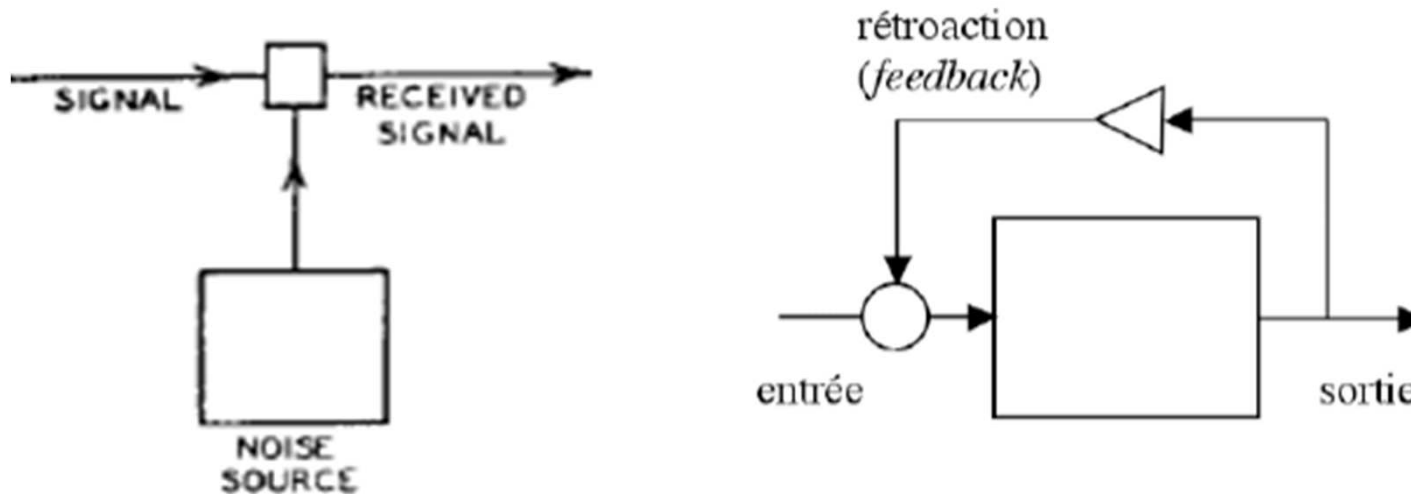
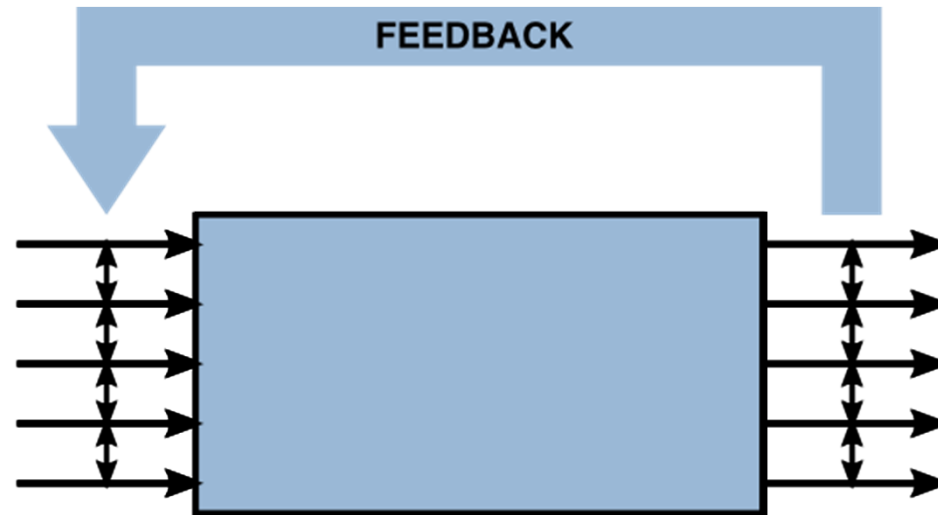

FIG. 1 – Boucle de rétroaction

60 years later...

MIMO Flexible Networks



We must **learn** and **control** the black box

- within **a fraction of time**
- with **finite energy**.

In many cases, the number of inputs/outputs (the dimensionality of the system) is of the same order as the time scale changes of the box.

Basics

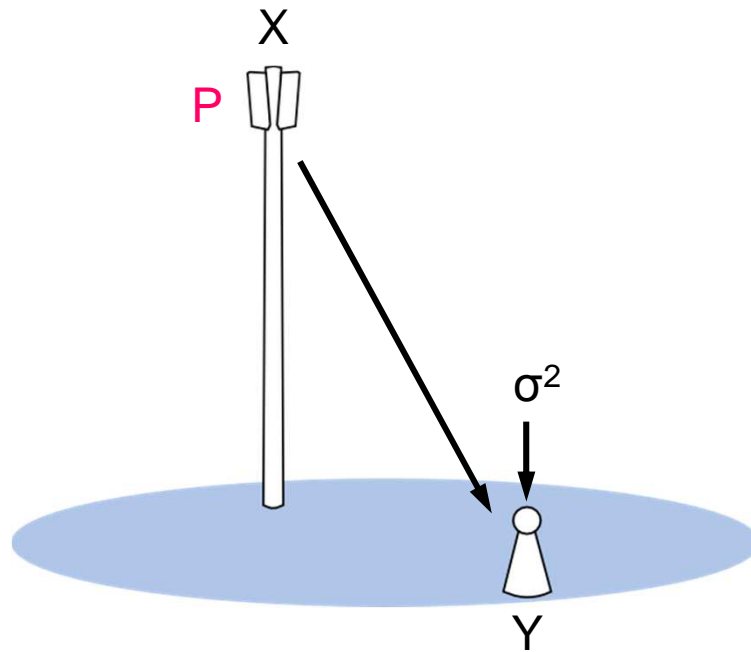

$$C_1 = \log(1+P/\sigma^2)$$

Basics

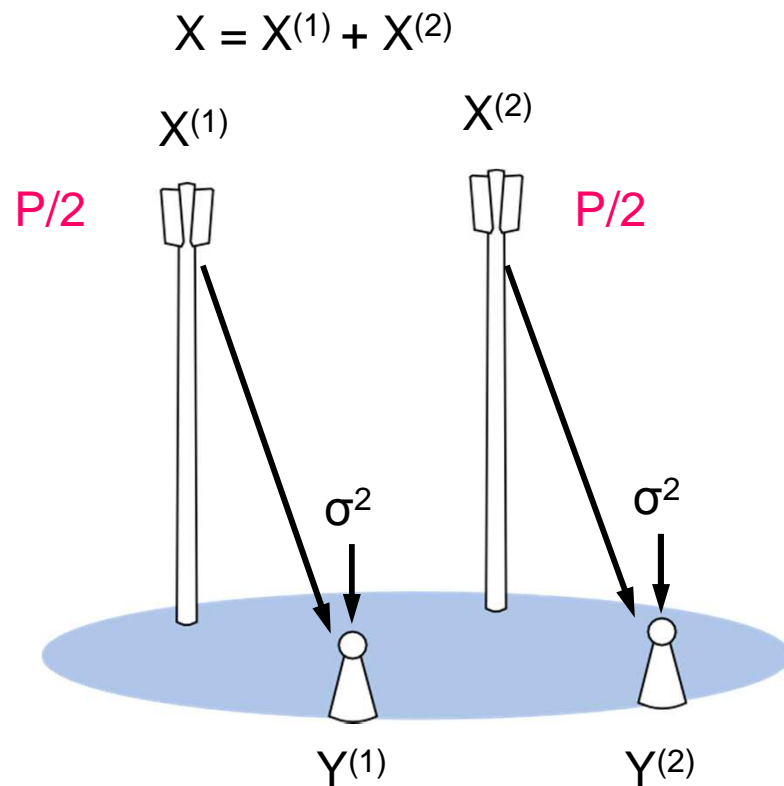

$$C_2^{(1)} = \log(1 + P/2\sigma^2)$$

+

$$C_2^{(2)} = \log(1 + P/2\sigma^2)$$



$$C_2 = C_2^{(1)} + C_2^{(2)} = 2\log(1 + P/2\sigma^2)$$

C_1 and C_2 , which is better?

$$C_1 = \log(1+P/\sigma^2) \quad \text{v.s.} \quad C_2 = 2\log(1+P/2\sigma^2)$$

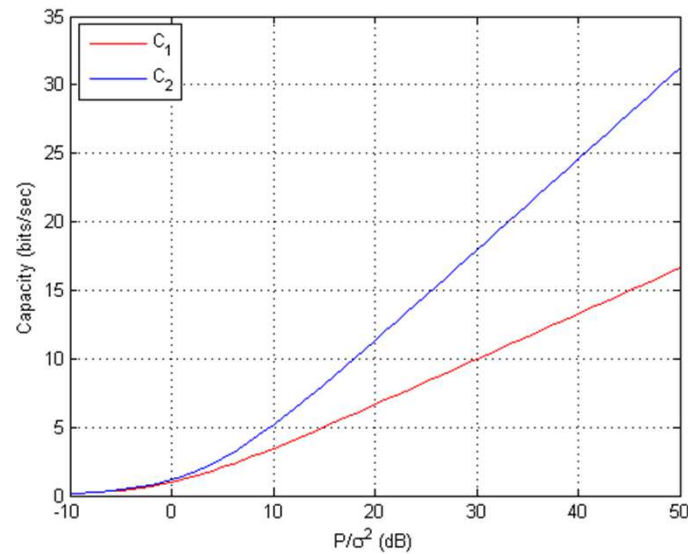

- Lesson learned:
 - High SNR regime
 - No need for transmit and receive cooperation

Nature

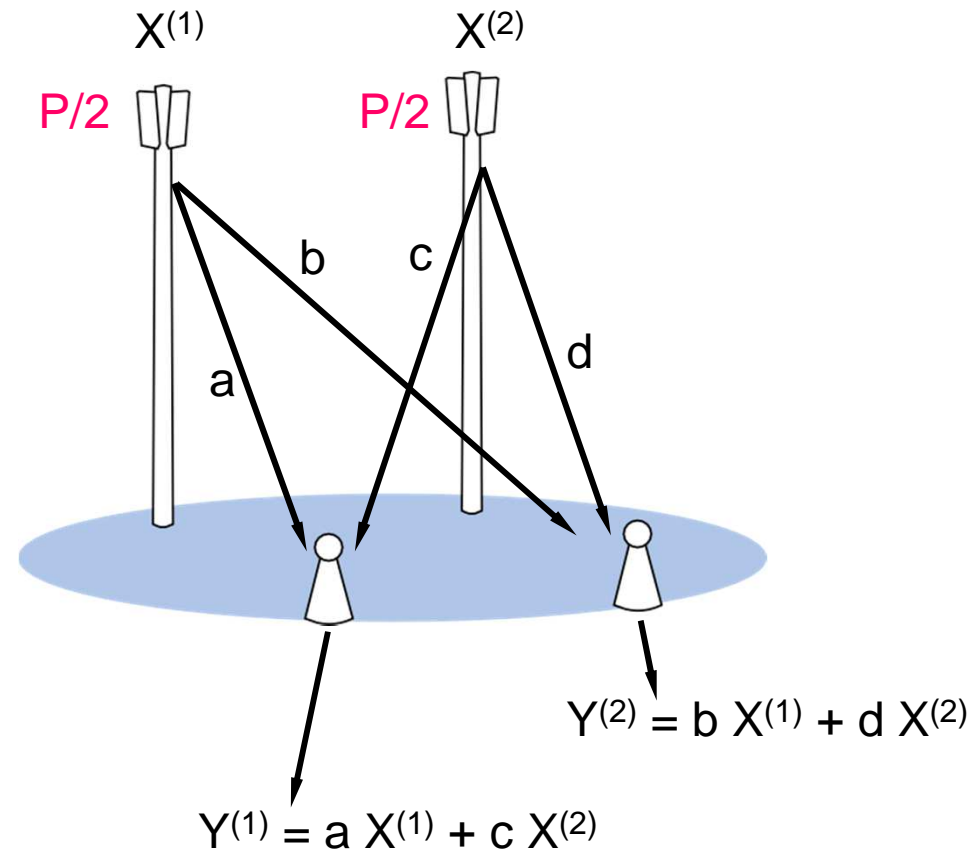

Receiver cooperation

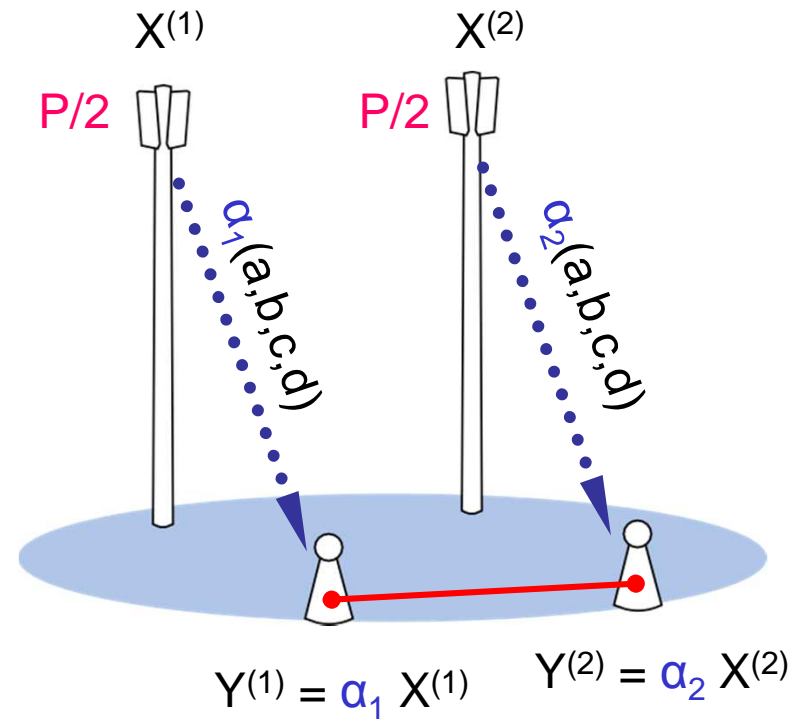

Transmitter cooperation

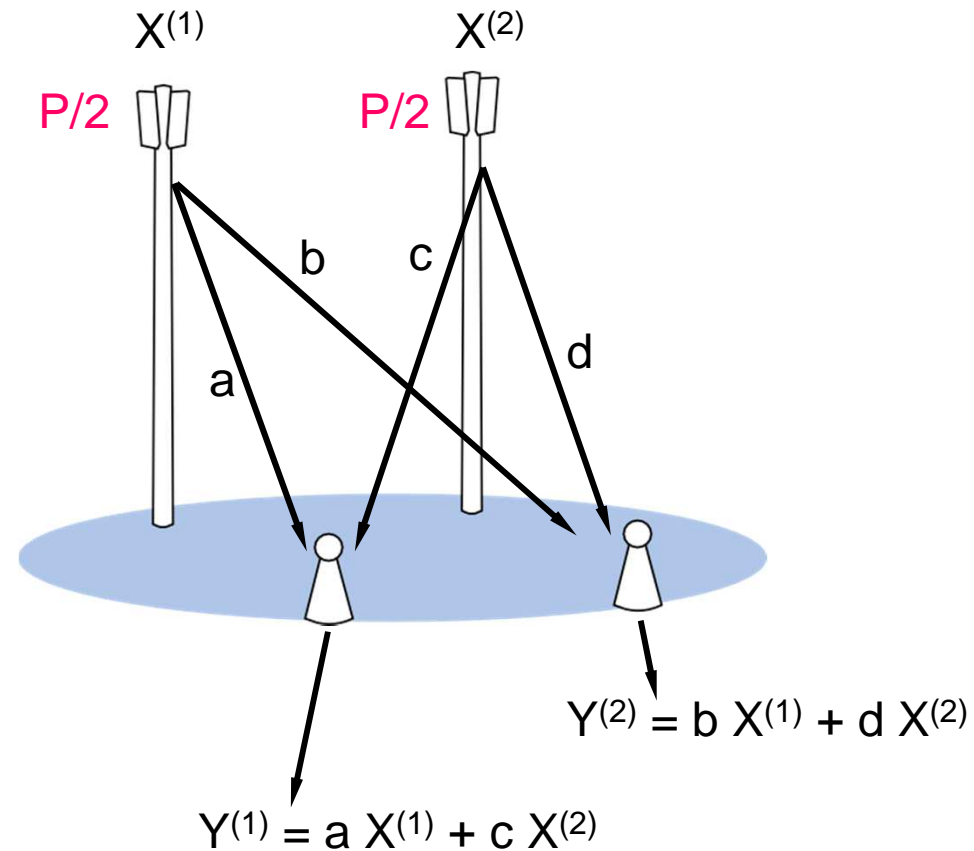

Transmitter cooperation

$$f_1(X^{(1)}, X^{(2)}, a, b, c, d)$$

$$f_2(X^{(1)}, X^{(2)}, a, b, c, d)$$

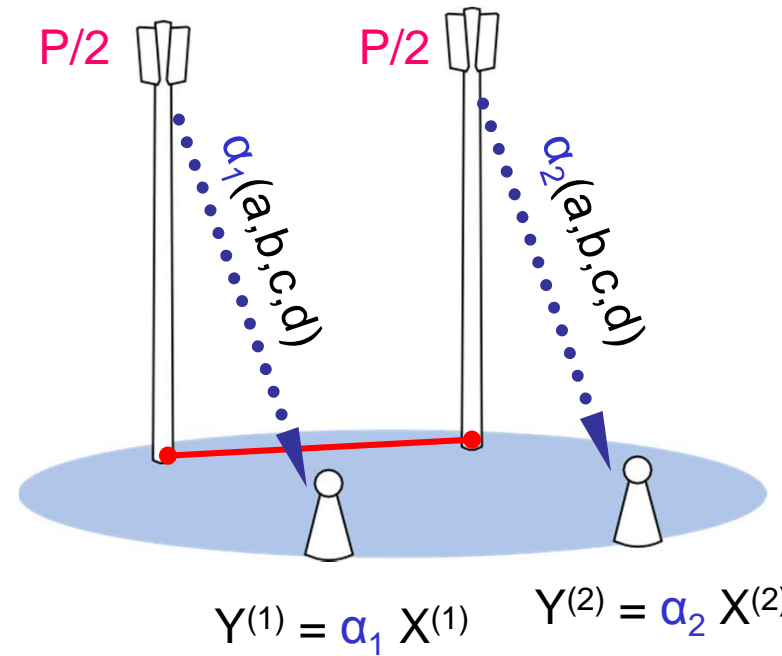

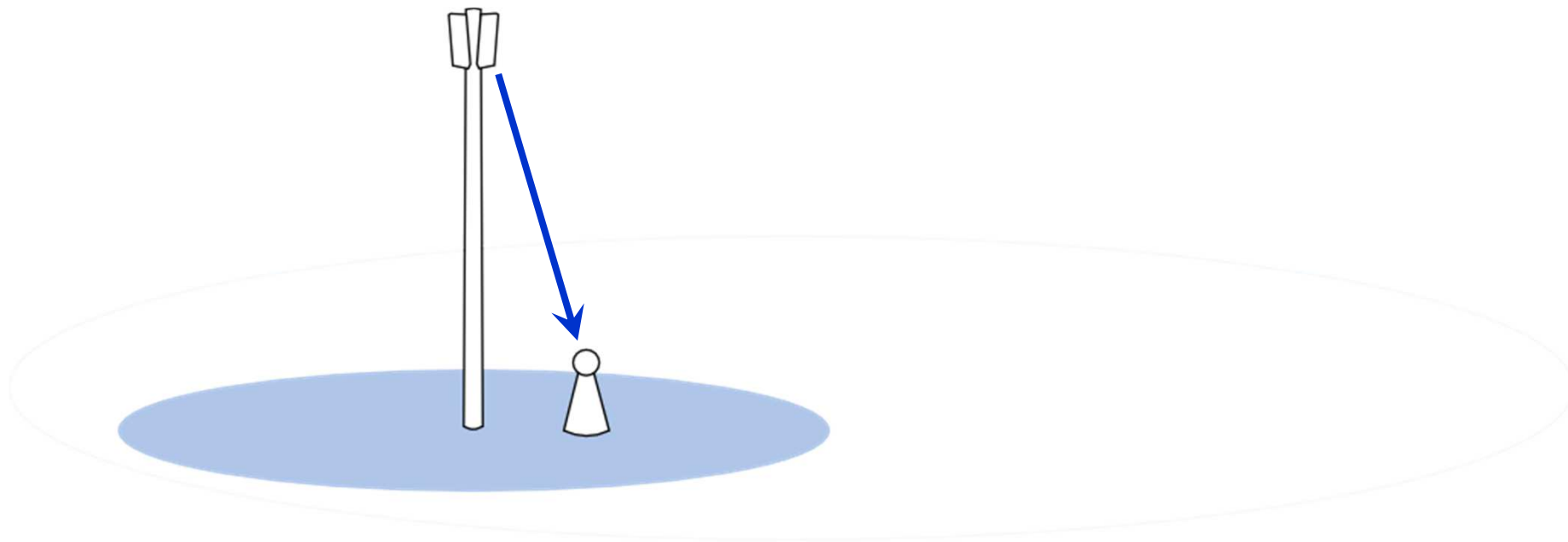

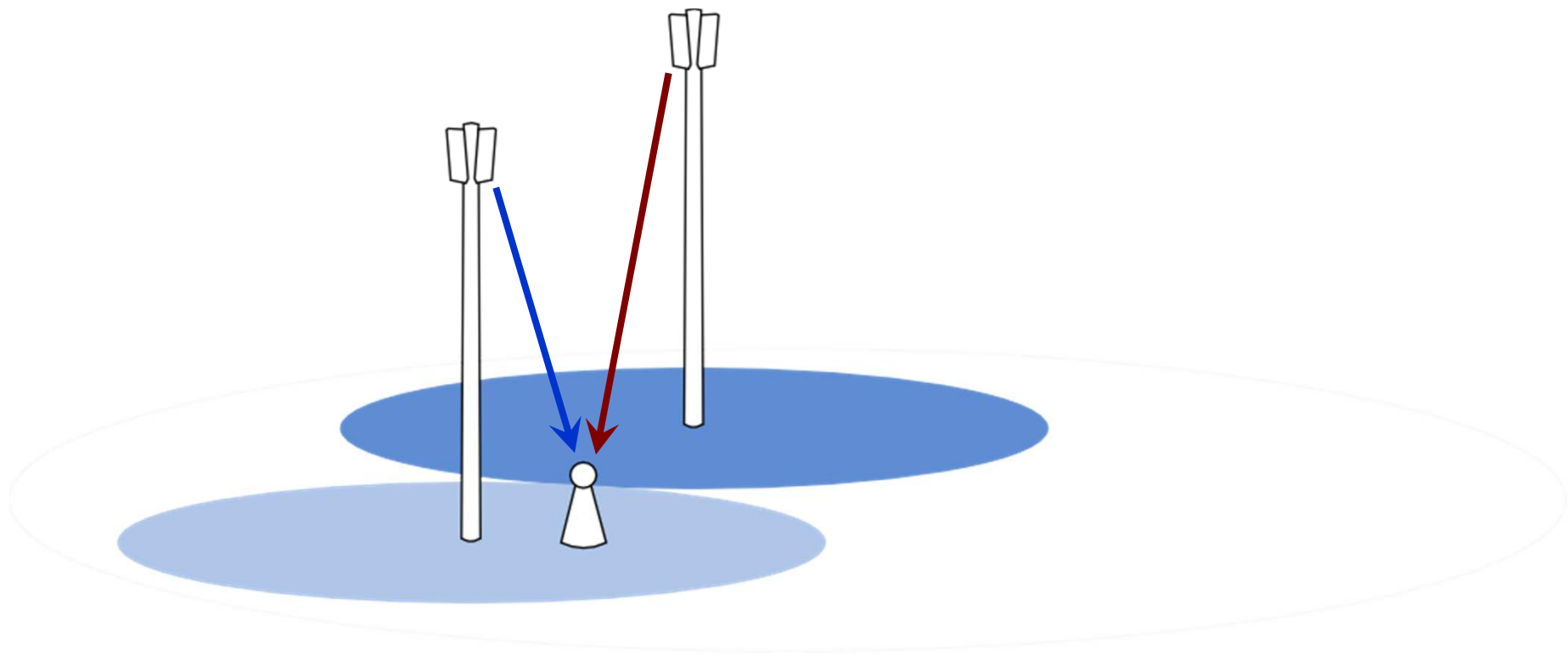

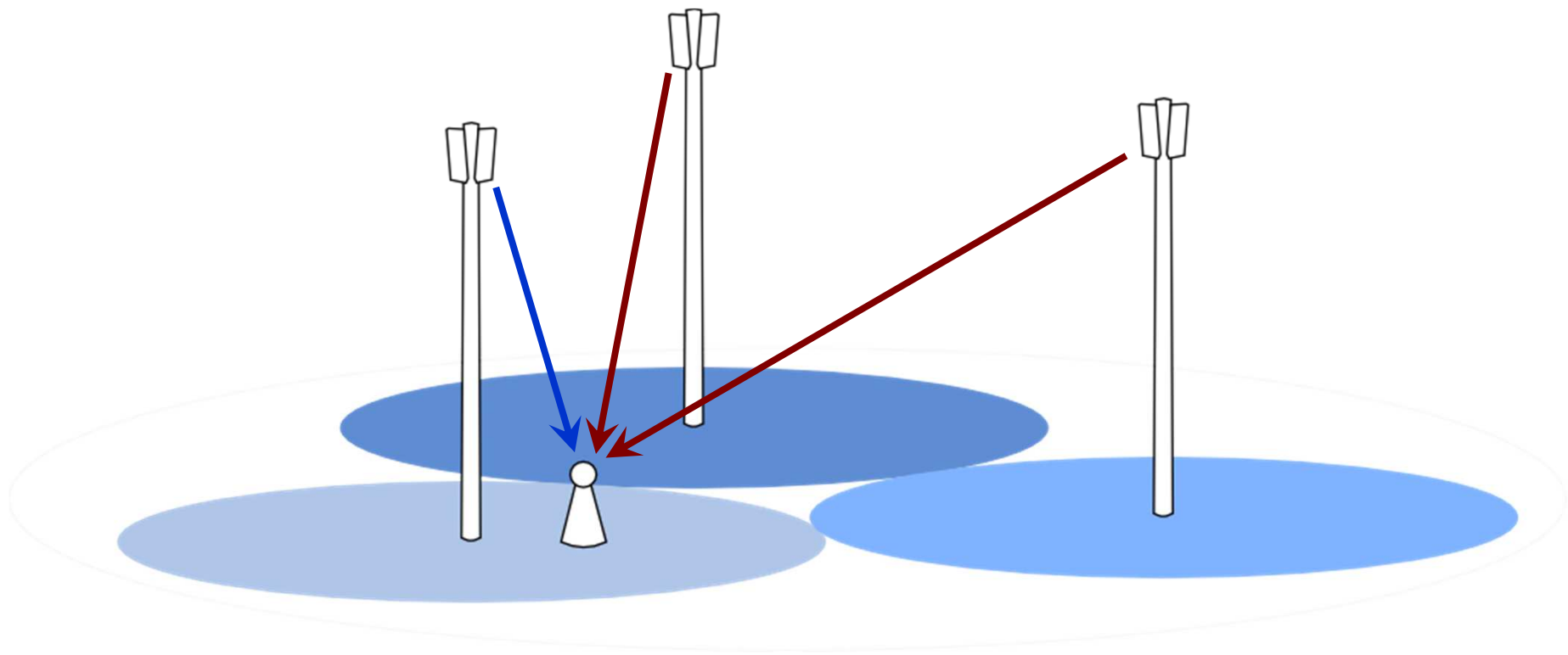

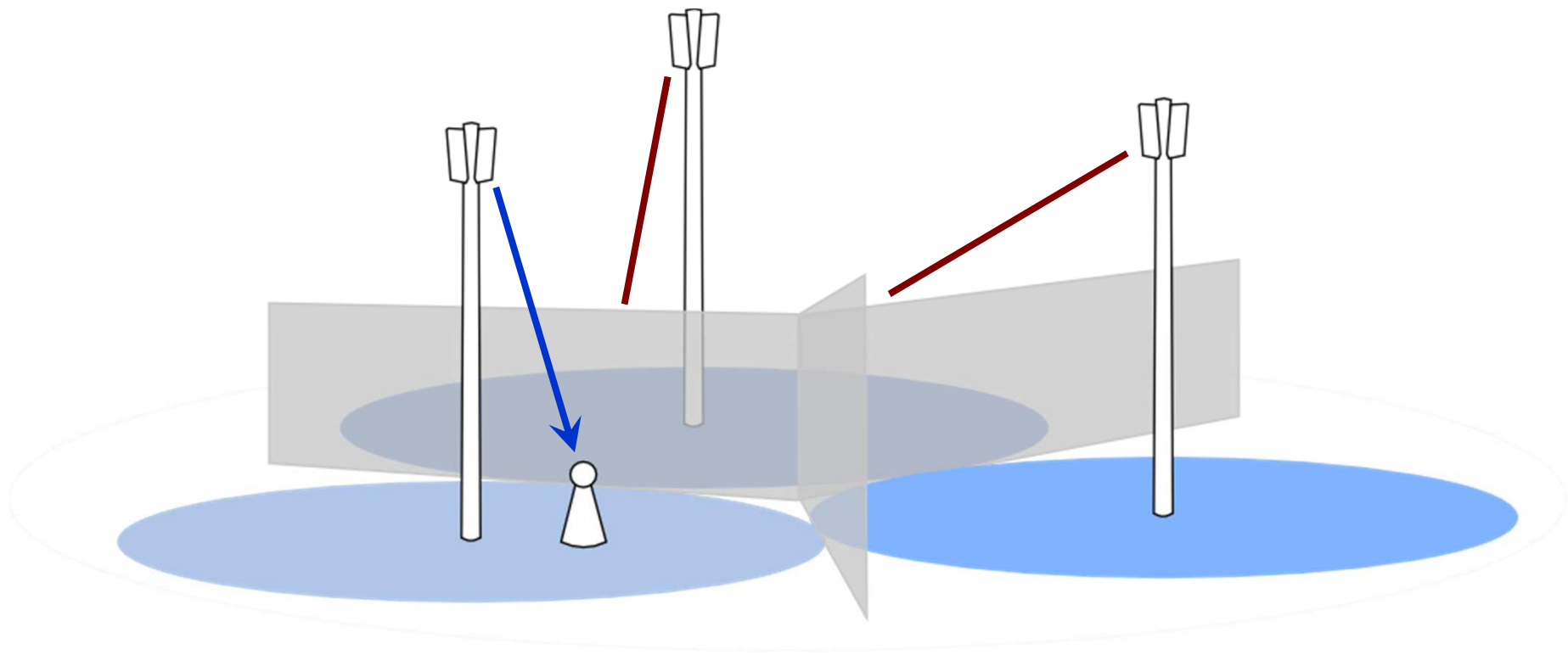

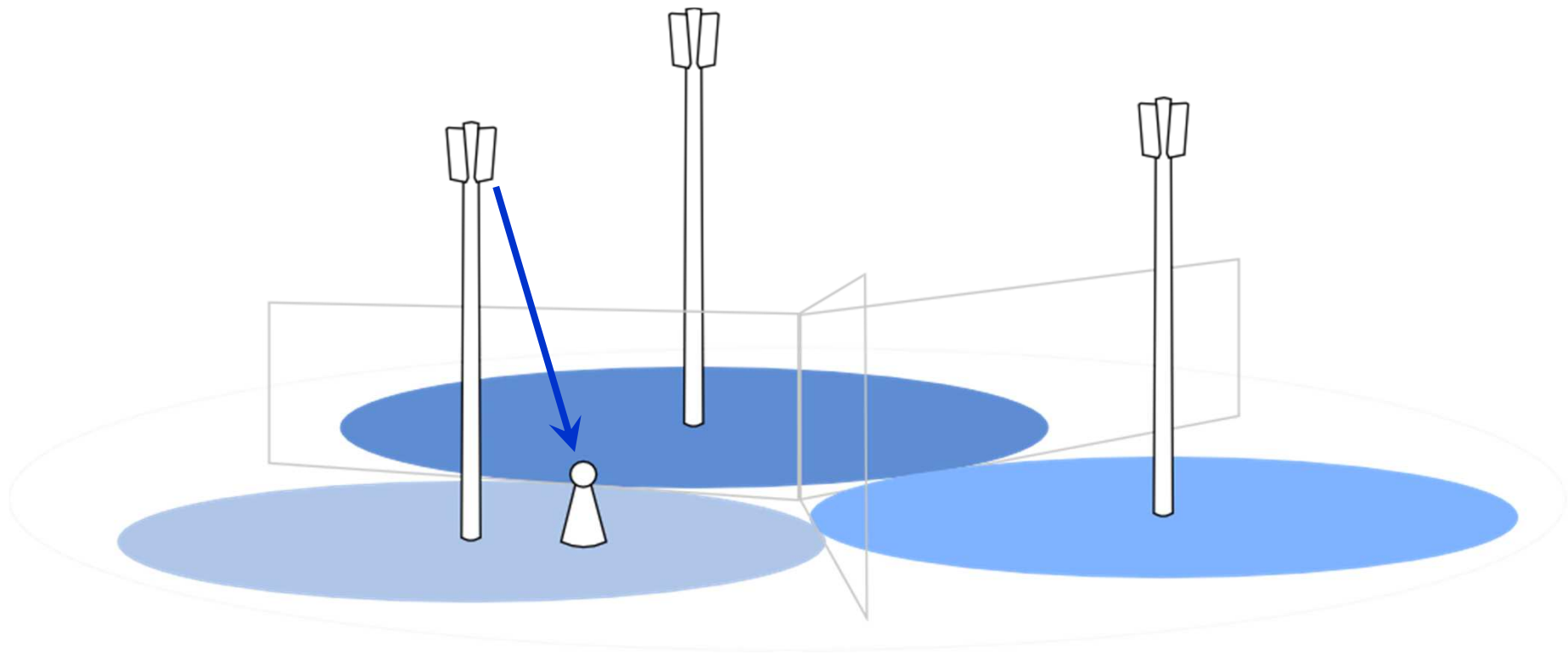

“We build too many walls and not enough bridges.”
Isaac Newton

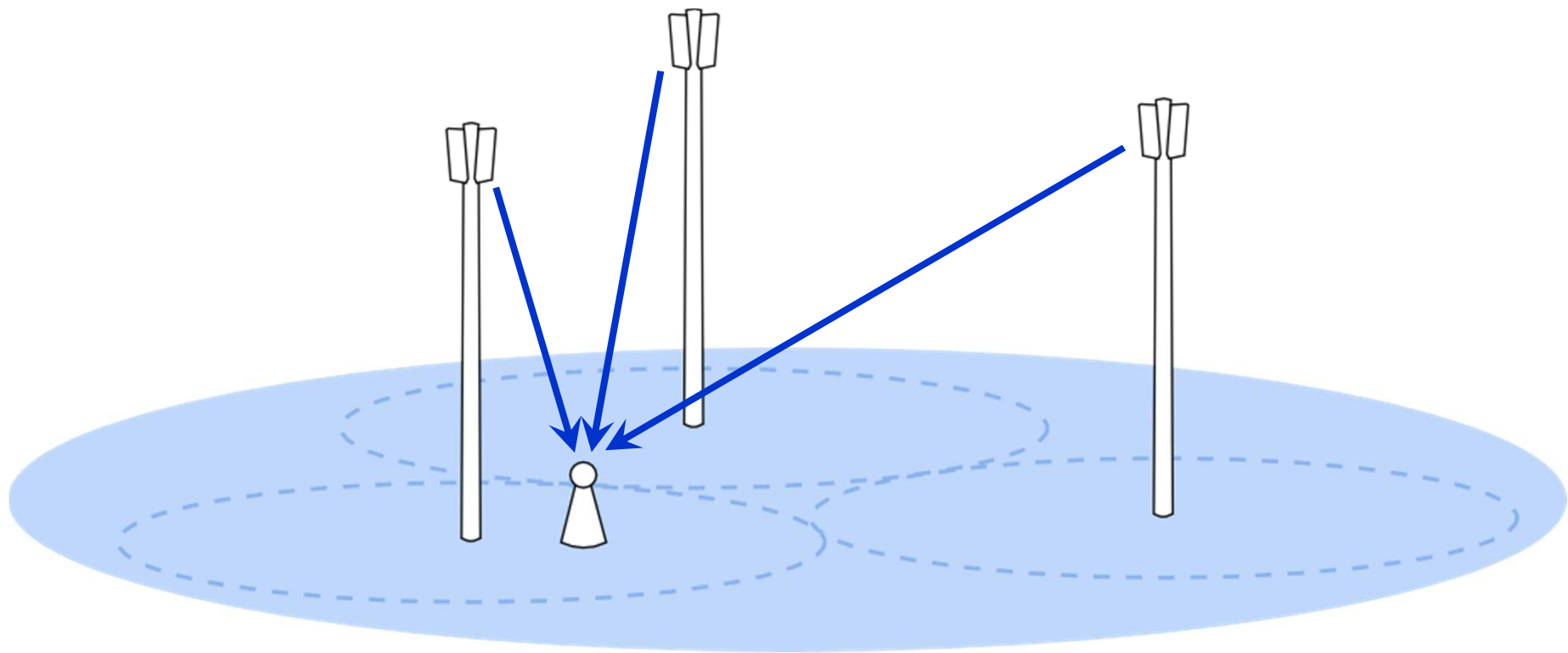

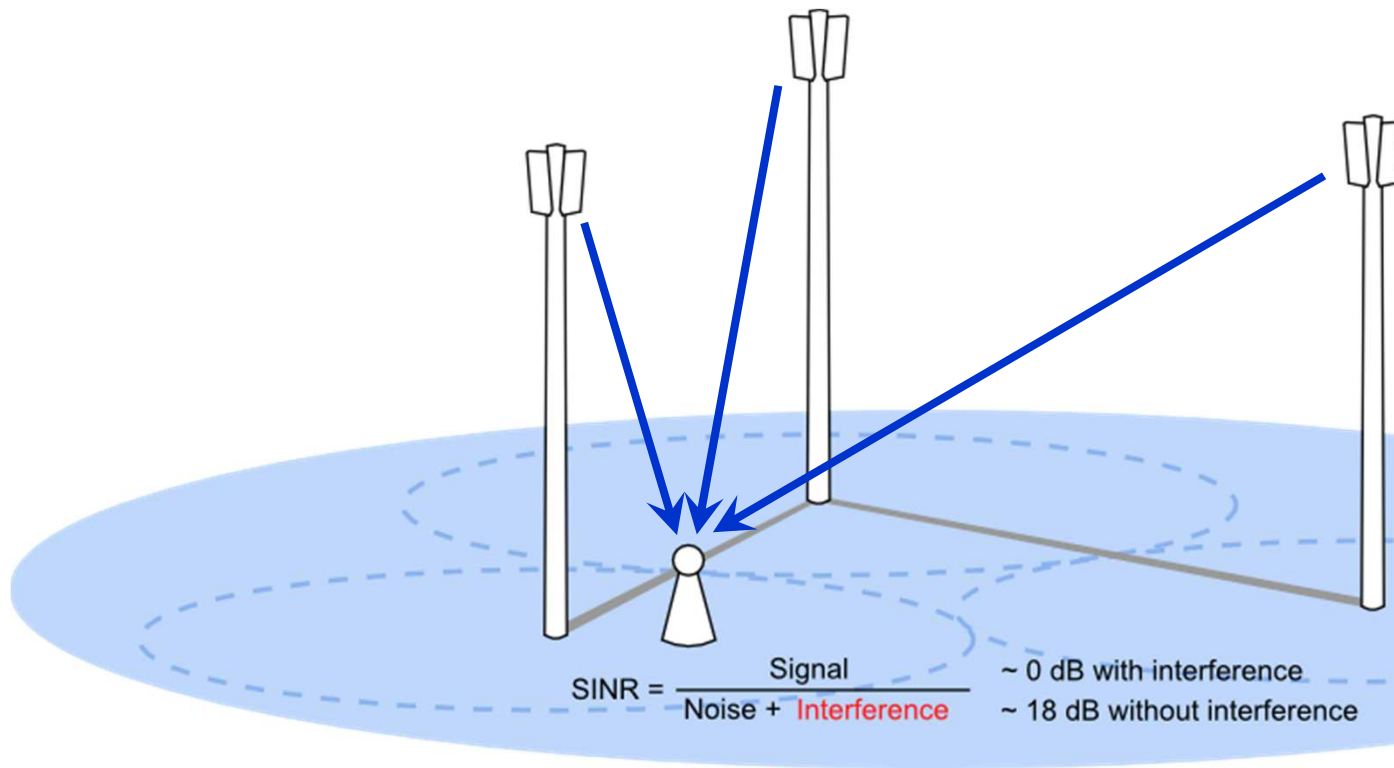

$$\text{SINR} = \frac{\text{Signal}}{\text{Noise} + \text{Interference}}$$

~ 0 dB with interference
 ~ 18 dB without interference

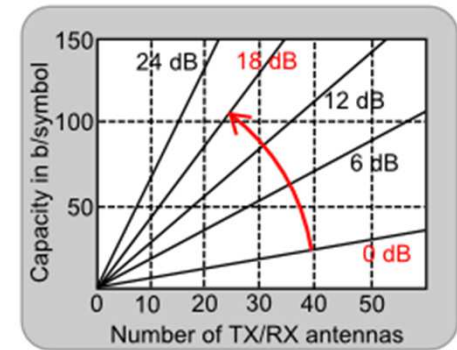

Network MIMO can greatly increase the efficiency of multiple antennas in cellular networks

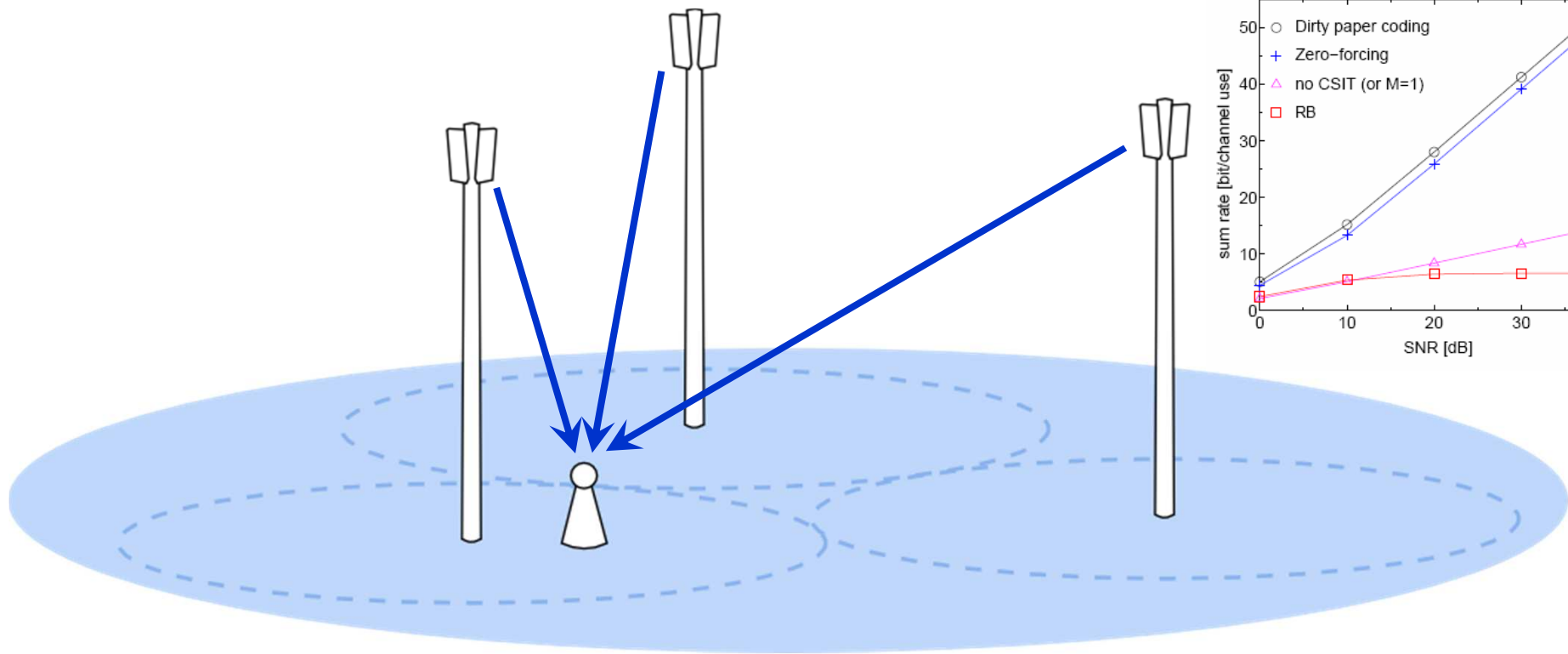

- For large SNR, the sum rate scales as $R_{sum} \sim M \log SNR$ with perfect channel state information at Tx and Rx (CSIT/R)
- The capacity is achieved by a combination of MMSE beamforming and interference pre-cancellation encoding, **Dirty-paper coding**

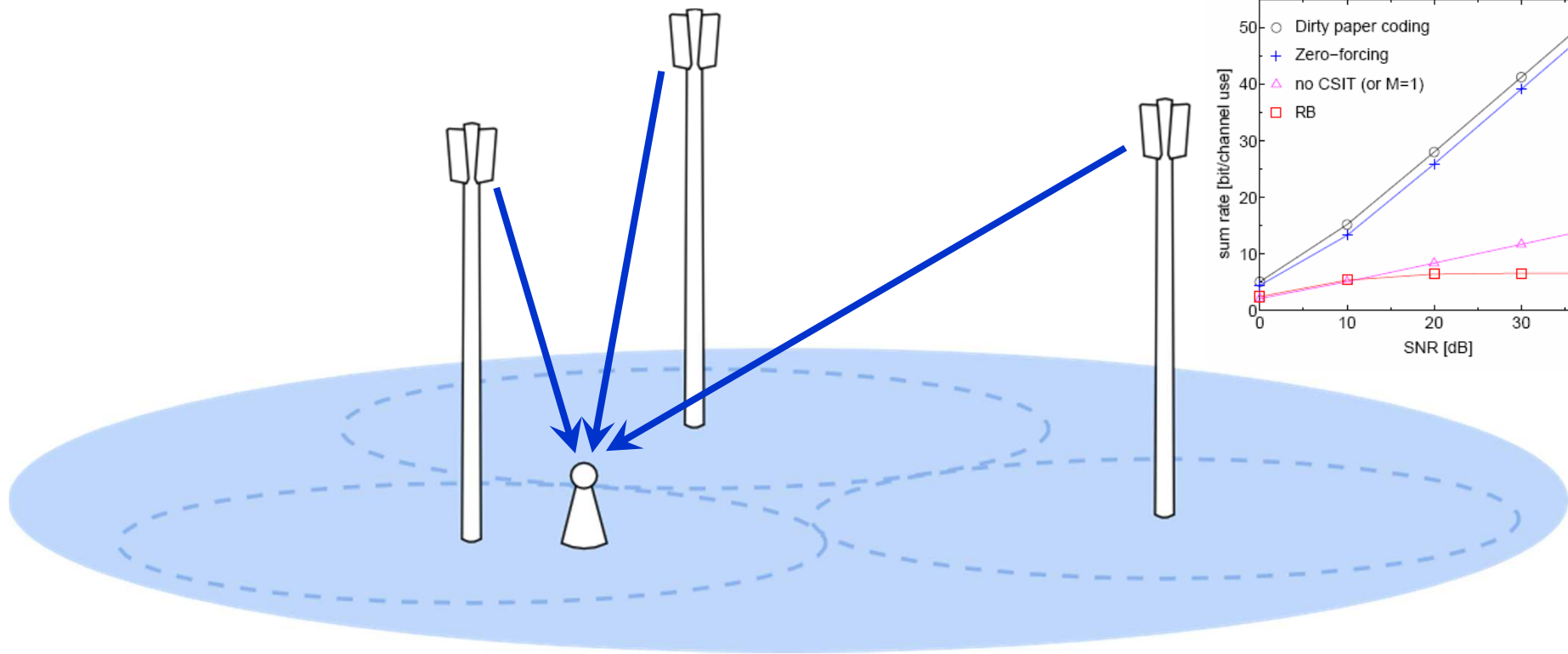

- Recent results show that a naive ZF with training and analog/digital feedback can indeed achieve the full multiplexing.
- The number of feedback bits should scale as $\log(\text{SNR})$.

What about beyond LTE schemes

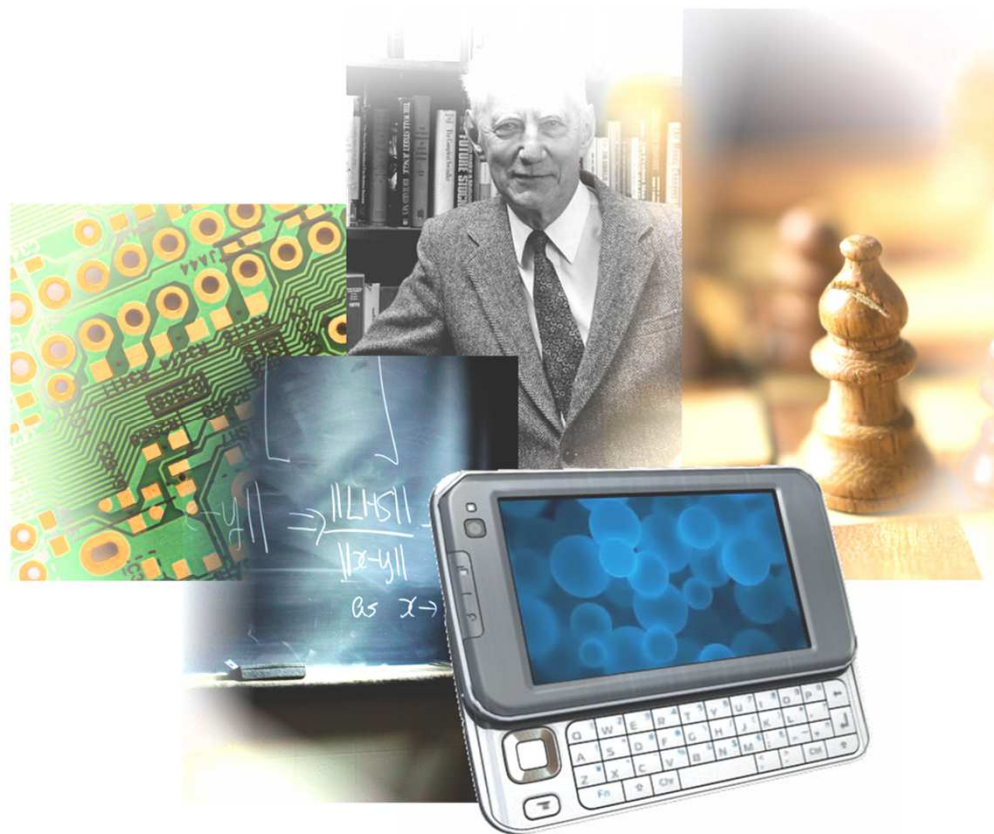

Network densification

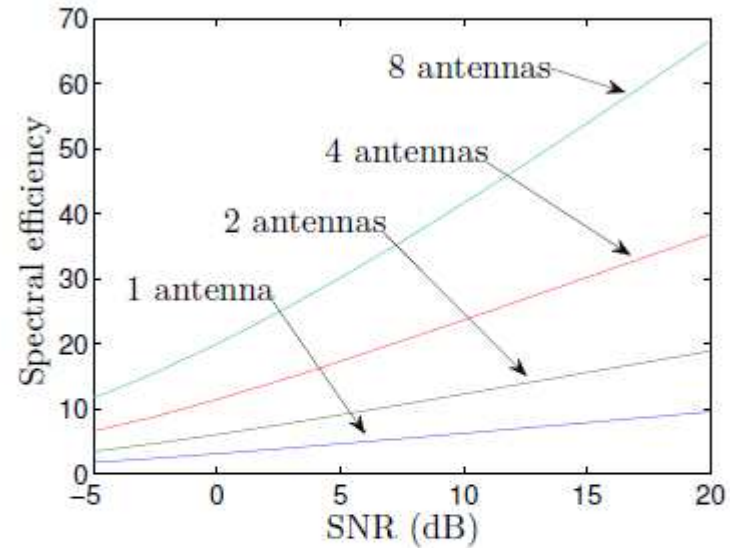
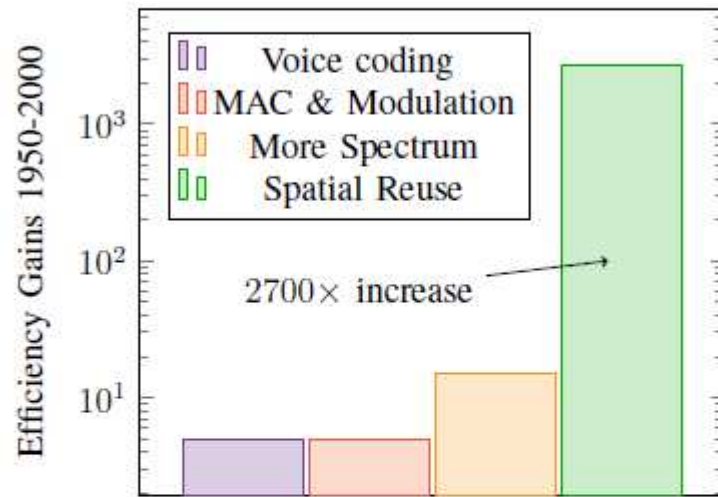

The exploding demand for wireless data traffic requires a massive network densification:

Densification: *"Increasing the number of antennas per unit area"*

Beyond LTE Schemes

- **Beyond LTE: (Long Term Evolution)**
 - ❑ An operating point where the number of serving antennas is 10 times the number of active users.
 - ❑ Is flexible in the deployment through a modular “lego” type network.

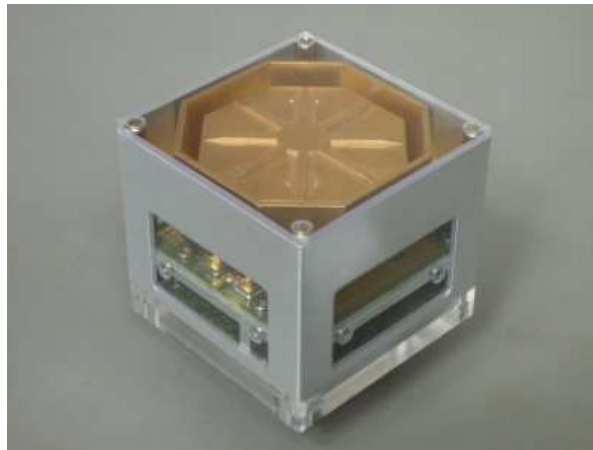

Bell Labs lightradio antenna module – the next generation small cell

(picture from www.washingtonpost.com)

“David vs Goliath“ or “Small Cells vs Massive MIMO“

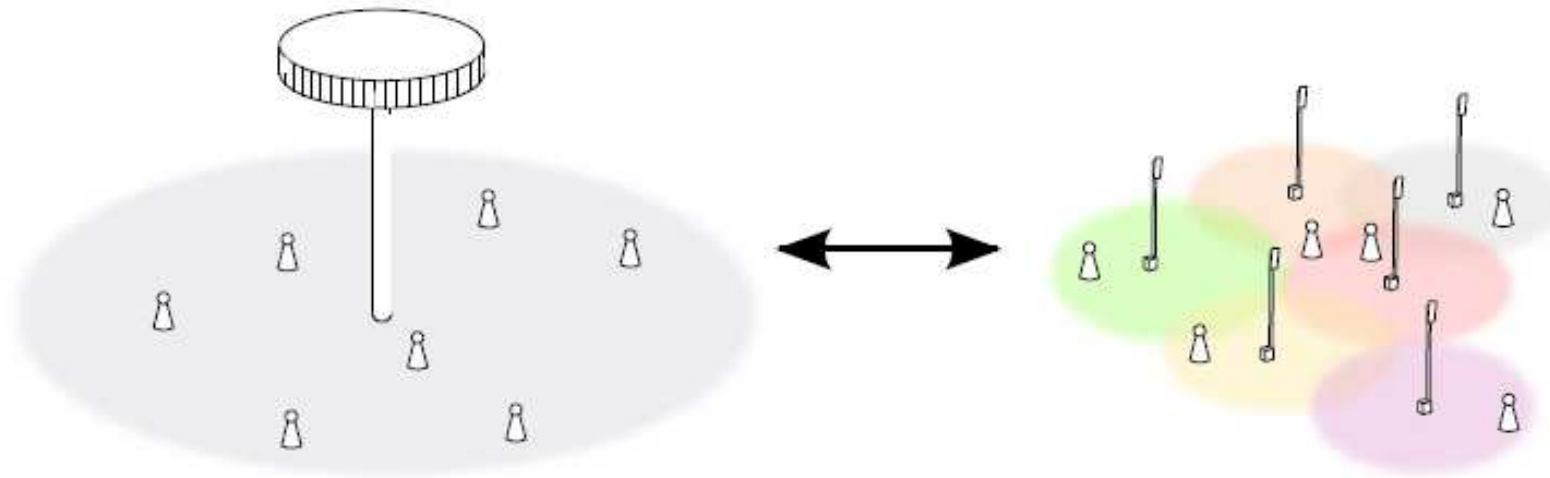

How to densify: *“More antennas or more BSs?”*

Questions:

- ▶ Should we install more base stations or simply more antennas per base?
- ▶ How can massively many antennas be efficiently used?

The 400-Antenna Base Station

- 400 antenna base station serves 40 active users via multi-user MIMO

The idea of massive MIMO

Canonical MIMO MAC with K transmitters and N receive antennas:

$$\mathbf{y} = \sqrt{\rho}\mathbf{H}\mathbf{x} + \mathbf{n}$$

where $\mathbf{H}_{ij} \sim \mathcal{CN}(0, 1)$, $\mathbf{x} \sim \mathcal{CN}(\mathbf{0}, \mathbf{I}_K)$ and $\mathbf{n} \sim \mathcal{CN}(\mathbf{0}, \mathbf{I}_N)$.

The matched filter becomes asymptotically optimal:

$$\frac{1}{N}\mathbf{H}^H\mathbf{H} \xrightarrow[N \rightarrow \infty]{\text{a.s.}} \mathbf{I}_K$$



(c) 128 antennas

Motivation of massive MIMO

Consider a $N \times K$ MIMO MAC:

$$\mathbf{y} = \sum_{k=1}^K \mathbf{h}_k x_k + \mathbf{n}$$

where \mathbf{h}_k, \mathbf{n} are i.i.d. with zero mean and unit variance.

By the strong law of large numbers:

$$\frac{1}{N} \mathbf{h}_m^H \mathbf{y} \xrightarrow[N \rightarrow \infty, K = \text{const.}]{\text{a.s.}} x_m$$

With an unlimited number of antennas,

- ▶ uncorrelated interference and noise vanish,
- ▶ the matched filter is optimal,
- ▶ the transmit power can be made arbitrarily small.

T. Marzetta, "Noncooperative cellular wireless with unlimited numbers of base station antennas" IEEE Trans. Wireless Commun., vol. 9, no. 11, pp. 3590-3600, Nov. 2010.

Infinitely Many Antennas: Forward-Link Capacity For 20 MHz Bandwidth, 42 Terminals per Cell, 500 μ sec Slot

Interference-limited: energy-per-bit can be made arbitrarily small!

Frequency Reuse	.95-Likely SIR (dB)	.95-Likely Capacity per Terminal (Mbits/s)	Mean Capacity per Terminal (Mbits/s)	Mean Capacity per Cell (Mbits/s)
1	-29	.016	44	1800
3	-5.8	.89	28	1200
7	8.9	3.6	17	730

				Mean Capacity per Cell (Mbits/s)
LTE Advanced (>= Release 10)				74

The Small Cells Flexible Framework

- **Idea:** A dense network of low-power base stations.

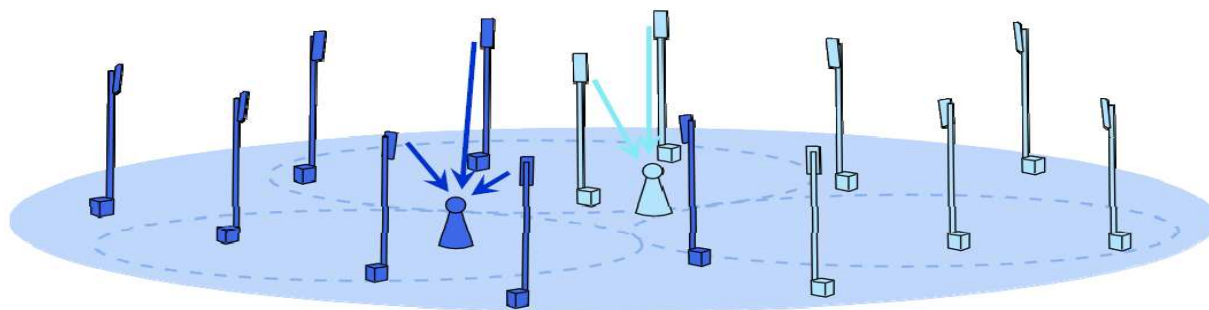

- **Motivation:**

- Higher spectral efficiency is achievable
- “Green” technology:
 - Reduced energy consumption at the base stations
 - Reduced electromagnetic pollution (using beamforming to intended users)

Cellular Dreams and Cordless Nightmares

**Life at Bell Laboratories
in Interesting Times**

Richard H. Frenkiel

Trials and Tribulations

By 1976, the time had come to prove that our many claims could be turned into a practical system. Small cell coverage over a large service area would require hundreds of cells and cost hundreds of millions of dollars, so we applied for permission to conduct two separate trials. A large-cell Market Trial in Chicago would provide realistic service to more than 2000 customers, while a small-cell “Test Bed” in Newark, New Jersey, would demonstrate that the smallest cells could provide good service in the presence of nearby interference. In combination, these trials would provide a complete demonstration of our system.

Motorola objected to our proposal as inadequate, since neither the trial in Chicago nor the Test Bed in Newark demonstrated a fully developed small-cell system. Chicago, they argued, used very large cells, while Newark was only a partial grid of small cells. Since a demonstration of small cells over a large area was clearly impractical, we were confident that the FCC would see Motorola’s objections for what they were—another smoke screen intended to delay progress. As it turned out, our faith was misplaced. The FCC ruled that our proposed trials were inadequate, using virtually the same arguments that Motorola had presented, and summarily denied our application.

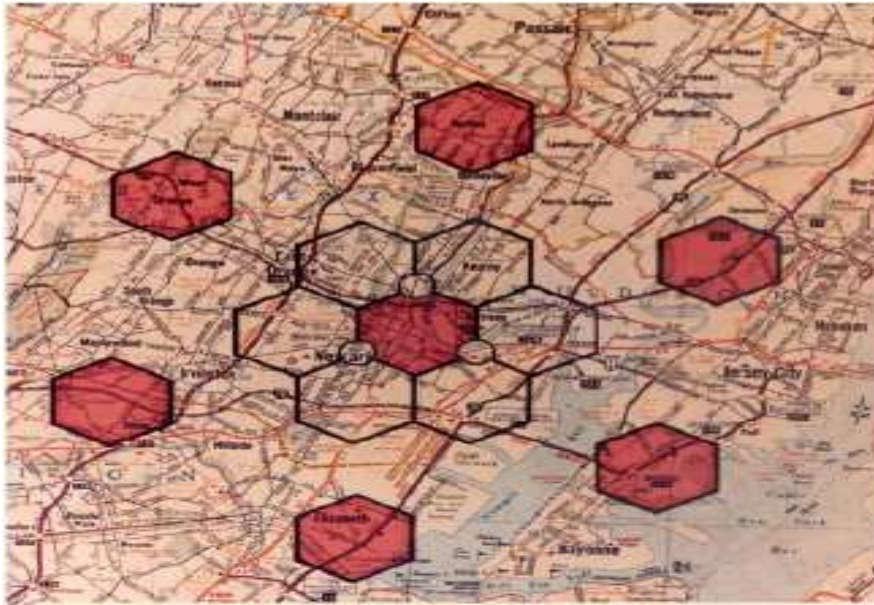

The partial small-cell grid in Newark and the Test Van

Our Goal: Self-Learning Base Station

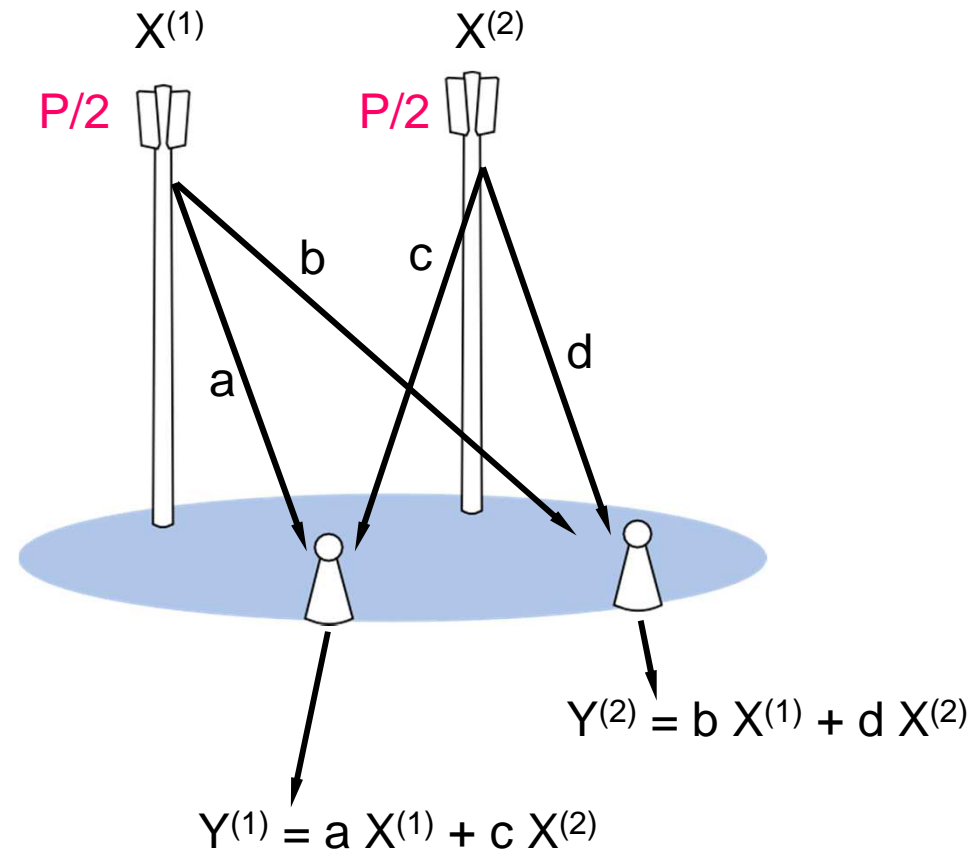



The Birth of the Nash Equilibrium

J. F. Nash, "Non-Cooperative Games", Doctoral Dissertation, Princeton University, 1950.



John Forbes Nash, Jr., 1928-

Our Goal: Self-Learning Base Station

$$f_1(X^{(1)}, X^{(2)}, a, b)$$

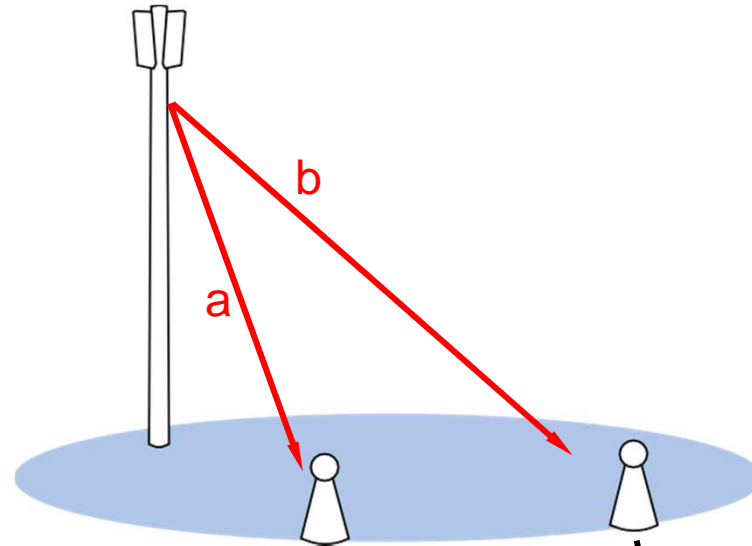

$$Y^{(1)} = a X^{(1)} + c X^{(2)}$$

$$Y^{(2)} = b X^{(1)} + d X^{(2)}$$

Our Goal: Self-Learning Base Station

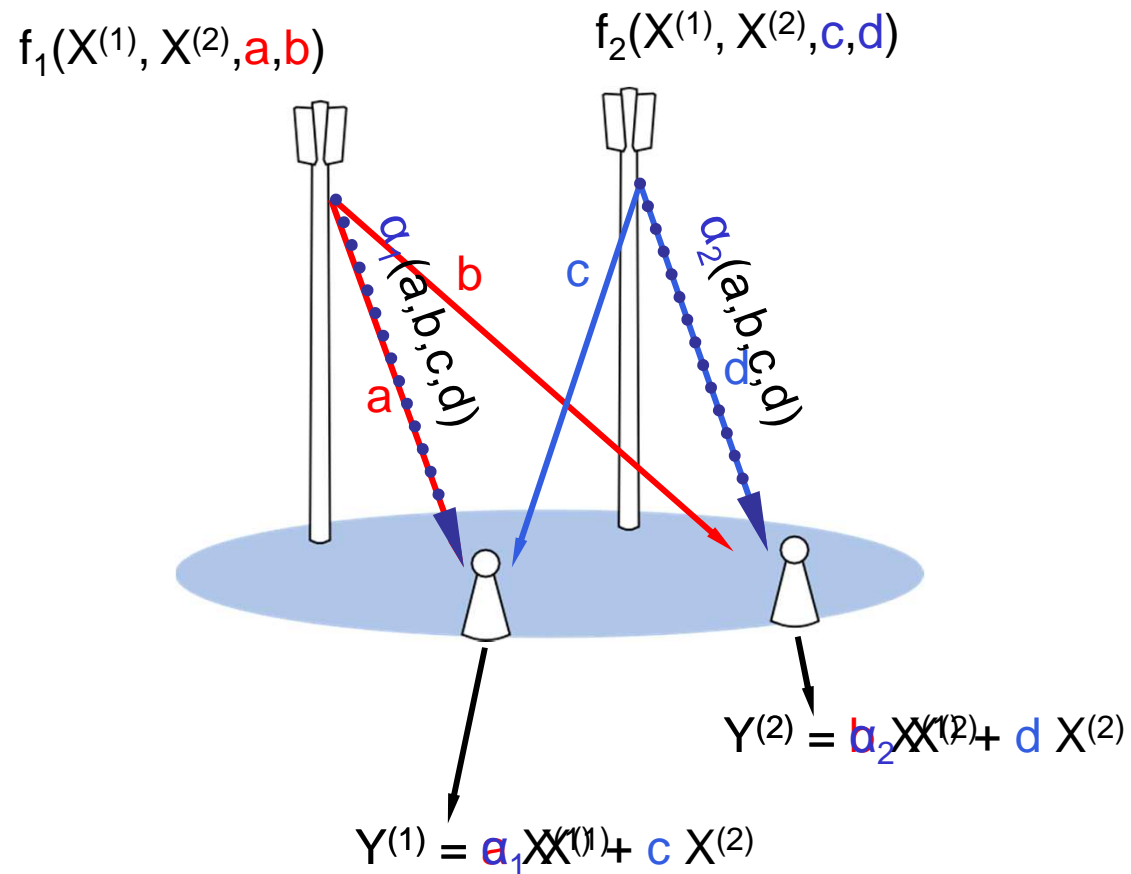

Shannon's Small Self-Learning Mouse

Computers and Automata*

CLAUDE E. SHANNON†, FELLOW, IRE

C. E. Shannon first became known for a paper in which he applied Boolean Algebra to relay switching circuits; this laid the foundation for the present extensive application of Boolean Algebra to computer design. Dr. Shannon, who is engaged in mathematical research at Bell Telephone Laboratories, is an authority on information theory. More recently he received wide notice for his ingenious maze-solving mechanical mouse, and he is well-known as one of the leading explorers into the exciting, but uncharted world of new ideas in the computer field.

The Editors asked Dr. Shannon to write a paper describing current experiments, and speculations concerning future developments in computer logic. Here is a real challenge for those in search of a field where creative ability, imagination, and curiosity will undoubtedly lead to major advances in human knowledge.—*The Editor*

Summary—This paper reviews briefly some of the recent developments in the field of automata and nonnumerical computation. A number of typical machines are described, including logic machines, game-playing machines and learning machines. Some theoretical questions and developments are discussed, such as a comparison of computers and the brain, Turing's formulation of computing machines and von Neumann's models of self-reproducing machines.

* Decimal classification: 621.385.2. Original manuscript received by the Institute, July 17, 1953.

† Bell Telephone Laboratories, Murray Hill, N. J.

INTRODUCTION

SAMUEL BUTLER, in 1871, completed the manuscript of a most engaging social satire, *Erewhon*. Three chapters of *Erewhon*, originally appearing under the title "Darwin Among the Machines," are a witty parody of *The Origin of Species*. In the topsy-turvy logic of satirical writing, Butler sees machines as gradually evolving into higher forms. He considers the classification of machines into genera, species and vari-

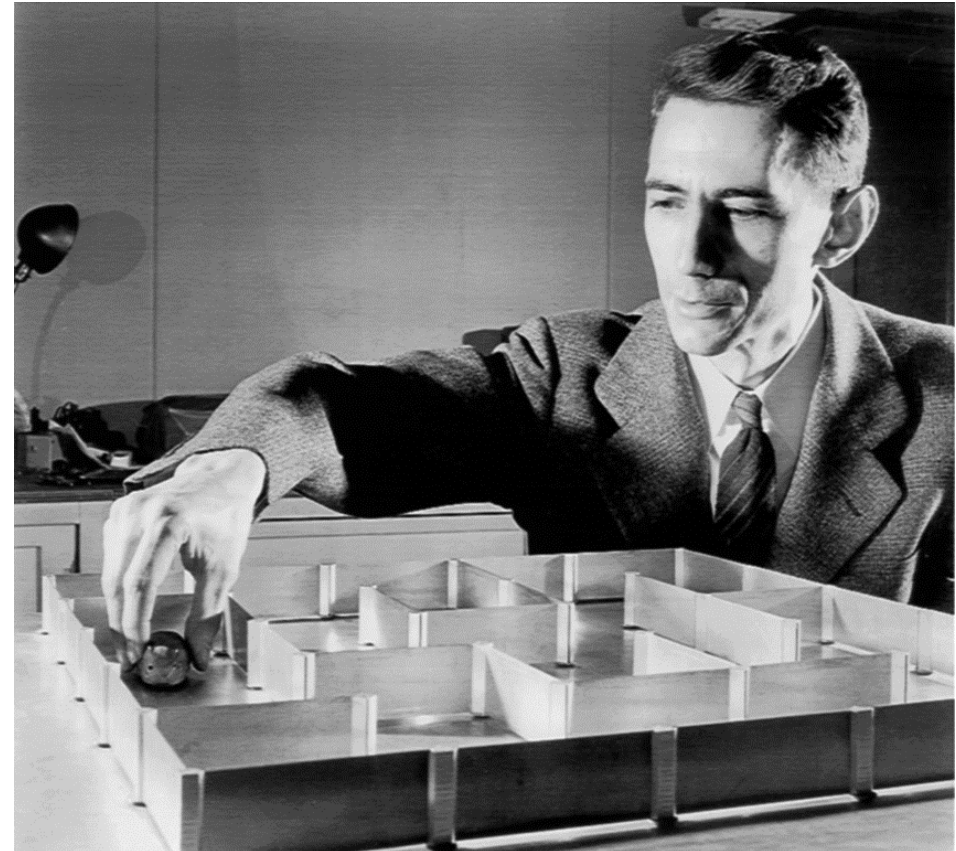

Computers and Automata*

CLAUDE E. SHANNON†, FELLOW, IRE

C. E. Shannon first became known for a paper in which he applied Boolean Algebra to relay switching circuits; this laid the foundation for the present extensive application of Boolean Algebra to computer design. Dr. Shannon, who is engaged in mathematical research at Bell Telephone Laboratories, is an authority on information theory. More recently he received wide notice for his ingenious maze-solving mechanical mouse, and he is well-known as one of the leading explorers into the exciting, but uncharted world of new ideas in the computer field.

The Editors asked Dr. Shannon to write a paper describing current experiments, and speculations concerning future developments in computer logic. Here is a real challenge for those in search of a field where creative ability, imagination, and curiosity will undoubtedly lead to major advances in human knowledge.—*The Editor*

Summary—This paper reviews briefly some of the recent developments in the field of automata and nonnumerical computation.

A number of typical machines are described, including logic machines, game-playing machines and learning machines. Some theoretical questions and developments are discussed, such as a comparison of computers and the brain, Turing's formulation of computing machines and von Neumann's models of self-reproducing machines.

* Decimal classification: 621.385.2. Original manuscript received by the Institute, July 17, 1953.

† Bell Telephone Laboratories, Murray Hill, N. J.

INTRODUCTION

SAMUEL BUTLER, in 1871, completed the manuscript of a most engaging social satire, *Erewhon*. Three chapters of *Erewhon*, originally appearing under the title "Darwin Among the Machines," are a witty parody of *The Origin of Species*. In the topsyturvy logic of satirical writing, Butler sees machines as gradually evolving into higher forms. He considers the classification of machines into genera, species and vari-

Motivation: How To Tackle the Challenge

Basic Turbo Decoding Concept:

- Two decoders iterate **beliefs** (probability measures) about the received sequence.
- The iteration process produces a **countinous improvement** of the **beliefs**
- The process converges when both decoders produce the same **beliefs**.

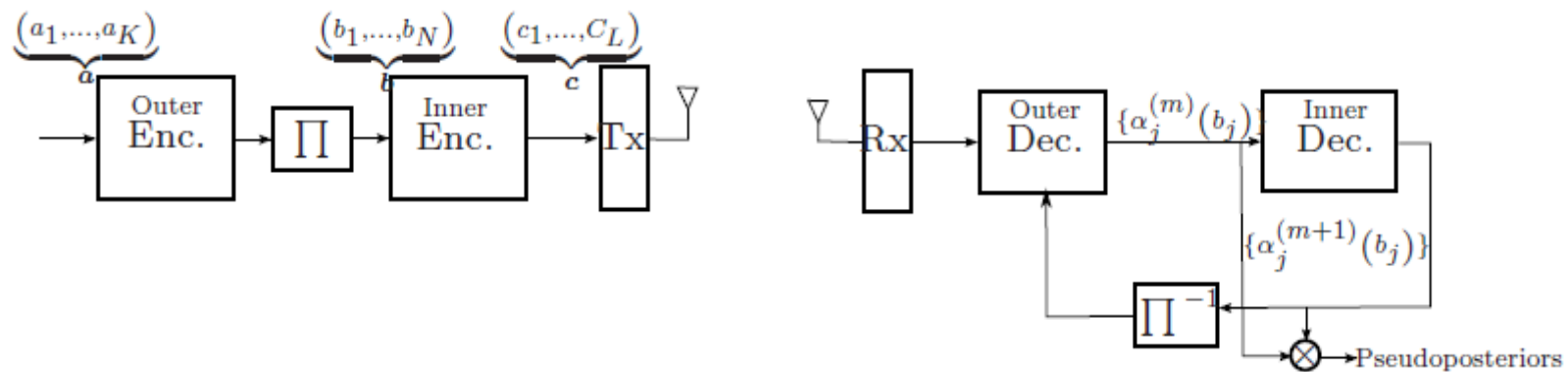

Motivation: How To Tackle the Challenge

What about **iterating with the transmitter**?

e.g., To use ACK/NACK, BER or SINR feedback to iteratively improve a **belief** of the optimal transmission configuration, given **the existence of other CRs**.

